

GENERAL INFORMATION

Product Support

Product support shall be provided by VIO as long as this product is still under warranty. VIO is not obliged to provide any repairs/ replacement on defects and damages caused by improper installation, improper operation, wrongful cleaning agents that deteriorate the surface appearance, force majeure and/or modifications made by user or third party.

Corrosion Protection

Do not expose luminaire to corrosive agents (e.g. salt, acid, chemical & cleaning agents) during installation or cleaning. These agents may cause corrosion on the luminaire.

Sizing Variation

Product	A	B	C	D	E	F	G	H
LUCID SINGLE	76	76	67	67	70	83	83	40

All measurements are in millimeters.

Cleaning and Care

Before cleaning, disconnect the luminaire from main supply and allow it to cool. Clean the external surface using lint free cloth with alcohol-free and non-abrasive cleaning agent.

Ambient Condition

LED luminaire performs best in an ambient temperature of <35°C. High ambient temperature may reduce the lifespan and efficiency of the LED driver and luminaire.



LUCID SINGLE

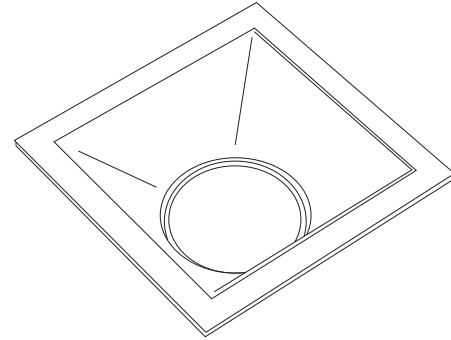

Installation Manual and Safety Instruction

Please read the installation manual carefully before commencement of installation.

Before carrying out any installation, please ensure that all power is switched off and disconnected from the main power supply.

This product must be installed by a qualified installer under local regulations.

The light source of the luminaire is not replaceable. When the light source reaches its end of life, the whole luminaire shall be replaced.

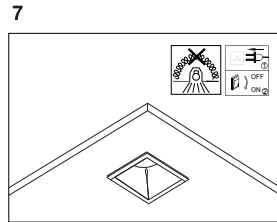
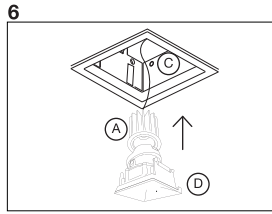
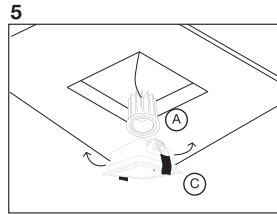
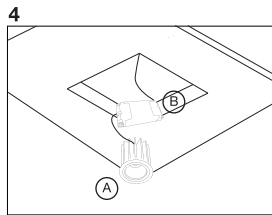
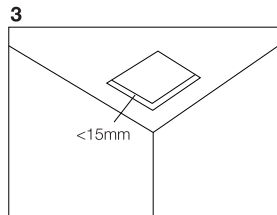
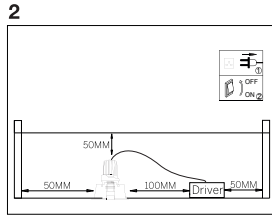
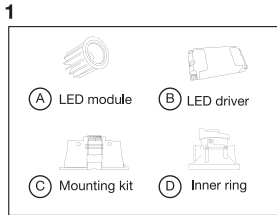

INSTALLATION INSTRUCTIONS

LUCID SINGLE

1. Ensure that you have received (A) a LED module, (B) a LED driver, (C) a mounting kit and (D) an inner ring.

2. Before installation or servicing, turn off and disconnect from main power supply. Ensure that there is at least 50mm clearance for LED driver and luminaire after installation.

3. This luminaire can accommodate a ceiling thickness of up to 15mm. Cut out a hole according to the recommended cut out dimension found in the GENERAL INFORMATION section.

4. Connect the (B) LED driver to the main incoming supply. Connect the (A) LED module to the (B) LED driver. Place the (B) LED driver on the false ceiling. Avoid placing the (B) LED driver near a heat source.

5. Insert the (C) mounting kit into the hole by engaging the torsion spring clips upwards and away from the trim. Ensure that the torsion spring clips are fully engaged in the ceiling and the luminaire is fully flush with the ceiling.

6. Securely attach the (A) LED module to the (D) inner ring and slot it into the (C) mounting kit until a distinct 'click' sound is heard.

7. Ensure that the luminaire and (B) LED driver are not covered with any thermally insulating material before switching on power.